

A - A

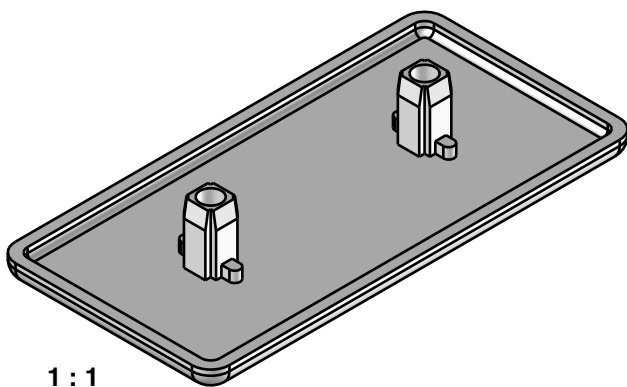
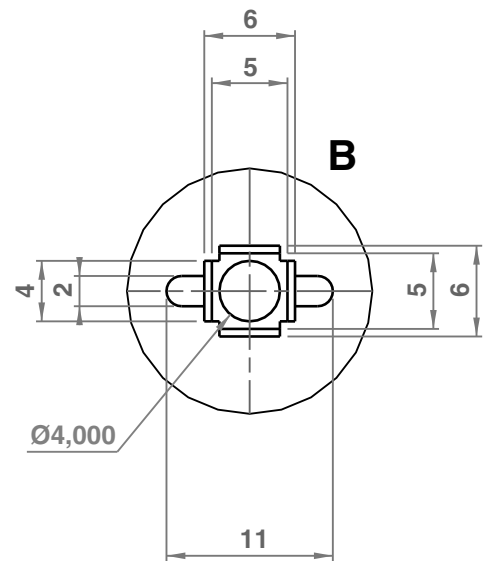

1 : 1

Allgemeintoleranz DIN ISO 20457	Schutzvermerk DIN 16016	Volumen 7,33cm ³	Material -	
 Dieselstr.14 - 61239 Ober-Mörlen Tel. 06002-930056 FAX -57 info@geyerwerkzeugbau.de www.geyerwerkzeugbau.de		Erstellt durch -	Erstellt am 05.10.2022	Artikelnr./WZ-Nr. 109-2
		Bauteil Beschreibung Abdeckung 40x80		Zeichnungsnr. 109-2
		Maßstab 1 : 1	Änd. -	Blatt 1/1